

Gitterbaner 50 - 600 mm

Festeplate

13 524 84	u/hull	sendzimir
13 524 85	u/hull	syrefast
13 524 86	u/hull	varmfors.
13 524 87	m/hull	sendzimir
13 524 88	m/hull	syrefast
13 524 89	m/hull	varmfors.

Veggfeste mini (55-75 mm bredde)

13 520 95	sendzimir
13 520 96	varmfors.
13 520 97	syrefast

Veggfeste (75-120 mm bredde)

13 520 39	sendzimir
13 520 40	varmfors.
13 520 41	syrefast

Takfeste

13 538 29	sendzimir
13 538 36	varmfors.

Ankerskinne 3 m, 41 x 21 mm

13 537 17	sendzimir
13 537 15	varmfors.

Gitterbane - 2,5 m

MP-729 E 13 521 18

Universalbrikke

13 520 36 sendzimir

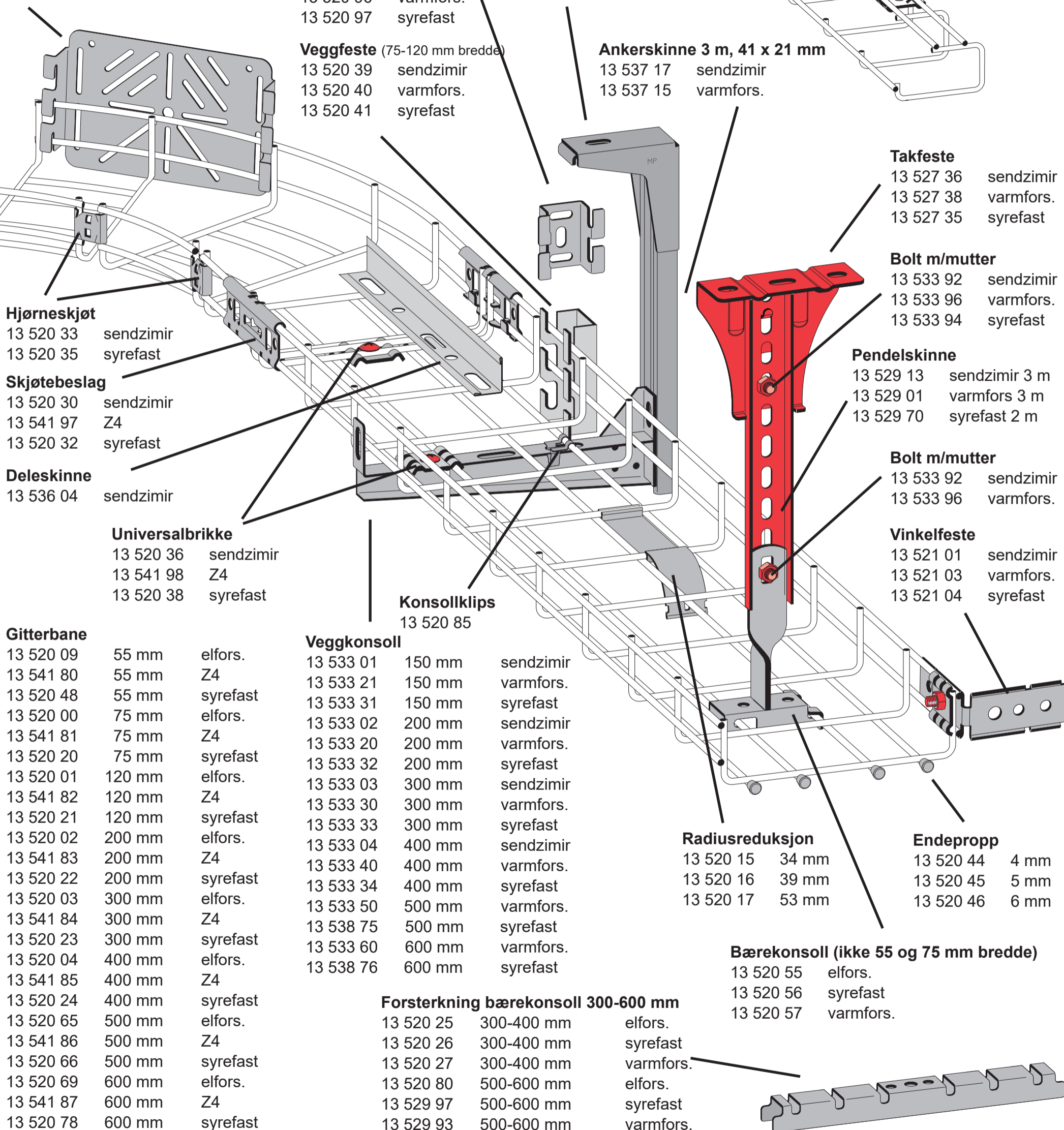

Hjørneskjøt

13 520 33	sendzimir
13 520 35	syrefast

Skjøtebeslag

13 520 30	sendzimir
13 541 97	Z4
13 520 32	syrefast

Deleskinne

13 536 04	sendzimir
-----------	-----------

Universalbrikke

13 520 36	sendzimir
13 541 98	Z4
13 520 38	syrefast

Gitterbane

13 520 09	55 mm	elfors.
13 541 80	55 mm	Z4
13 520 48	55 mm	syrefast
13 520 00	75 mm	elfors.
13 541 81	75 mm	Z4
13 520 20	75 mm	syrefast
13 520 01	120 mm	elfors.
13 541 82	120 mm	Z4
13 520 21	120 mm	syrefast
13 520 02	200 mm	elfors.
13 541 83	200 mm	Z4
13 520 22	200 mm	syrefast
13 520 03	300 mm	elfors.
13 541 84	300 mm	Z4
13 520 23	300 mm	syrefast
13 520 04	400 mm	elfors.
13 541 85	400 mm	Z4
13 520 24	400 mm	syrefast
13 520 65	500 mm	elfors.
13 541 86	500 mm	Z4
13 520 66	500 mm	syrefast
13 520 69	600 mm	elfors.
13 541 87	600 mm	Z4
13 520 78	600 mm	syrefast

Veggkonsoll

13 533 01	150 mm	sendzimir
13 533 21	150 mm	varmfors.
13 533 31	150 mm	syrefast
13 533 02	200 mm	sendzimir
13 533 20	200 mm	varmfors.
13 533 32	200 mm	syrefast
13 533 03	300 mm	sendzimir
13 533 30	300 mm	varmfors.
13 533 33	300 mm	syrefast
13 533 04	400 mm	sendzimir
13 533 40	400 mm	varmfors.
13 533 34	400 mm	syrefast
13 533 50	500 mm	varmfors.
13 538 75	500 mm	syrefast
13 533 60	600 mm	varmfors.
13 538 76	600 mm	syrefast

Forsterkning bærekonsoll 300-600 mm

13 520 25	300-400 mm	elfors.
13 520 26	300-400 mm	syrefast
13 520 27	300-400 mm	varmfors.
13 520 80	500-600 mm	elfors.
13 529 97	500-600 mm	syrefast
13 529 93	500-600 mm	varmfors.

Takfeste

13 527 36	sendzimir
13 527 38	varmfors.
13 527 35	syrefast

Bolt m/mutter

13 533 92	sendzimir
13 533 96	varmfors.
13 533 94	syrefast

Pendelskinne

13 529 13	sendzimir 3 m
13 529 01	varmfors 3 m
13 529 70	syrefast 2 m

Bolt m/mutter

13 533 92	sendzimir
13 533 96	varmfors.

Vinkelfeste

13 521 01	sendzimir
13 521 03	varmfors.
13 521 04	syrefast

Radiusreduksjon

13 520 15	34 mm
13 520 16	39 mm
13 520 17	53 mm

Endepropp

13 520 44	4 mm
13 520 45	5 mm
13 520 46	6 mm

Bærekonsoll (ikke 55 og 75 mm bredde)

13 520 55	elfors.
13 520 56	syrefast
13 520 57	varmfors.

Z4 - overflatebehandling tilsvarer en tykkelse på galvanisering på 85µm i forhold til 65µm som er standard varmgalvanisering

Gitterbaner montasjetips

Rett skjõt

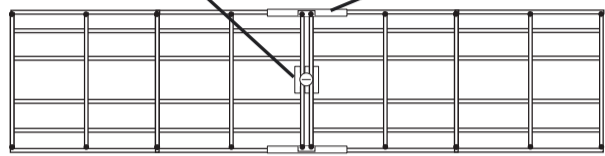

Universalbrikken monteres fra undersiden (bredde 300-400 mm)

B	Skjõt MP-730	Universalbrikke MP-731
75	2 st	-
120	2 st	-
200	2 st	-
300	2 st	1 st
400	2 st	2 st

Nivåavvinkling

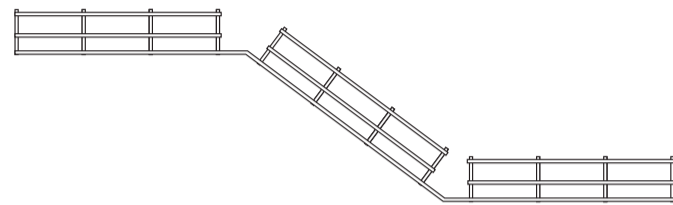

Gitterbanenes sider klippes bort og den bøyes i ønsket vinkel

L-avgrening med radius

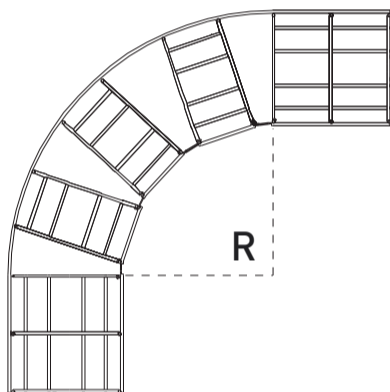

B	Klipte felt	Hjørneskjõt MP-732	Radius
75	1 st	1 st	-
120	2 st	2 st	90 mm
200	4 st	4 st	260 mm
300	6 st	6 st	420 mm
400	8 st	8 st	580 mm

Festebøyle

Festebøylene brukes sammen med veggfeste (MP-735) for montasje av gitterbane på valgfri type kabelstige

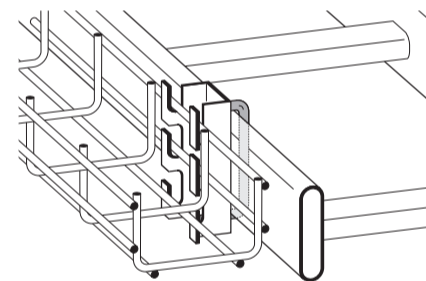
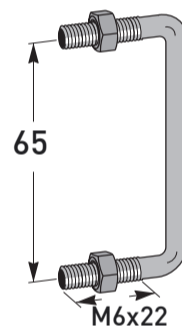

Dobbelmontasje

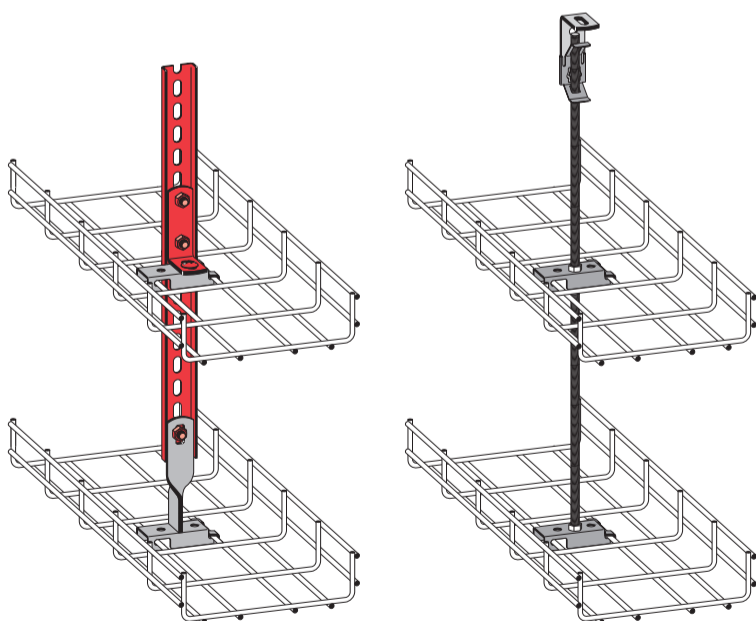

Montasje med rørfeste

